



**DC INVERTER**

# **AIR TO WATER HEAT PUMP**

**H series: Only Heating series**

**AC series: Heating & Cooling series**

**HC series: Multifunctional Heating Cooling & Hot water**

**Installation and Operation Manual**

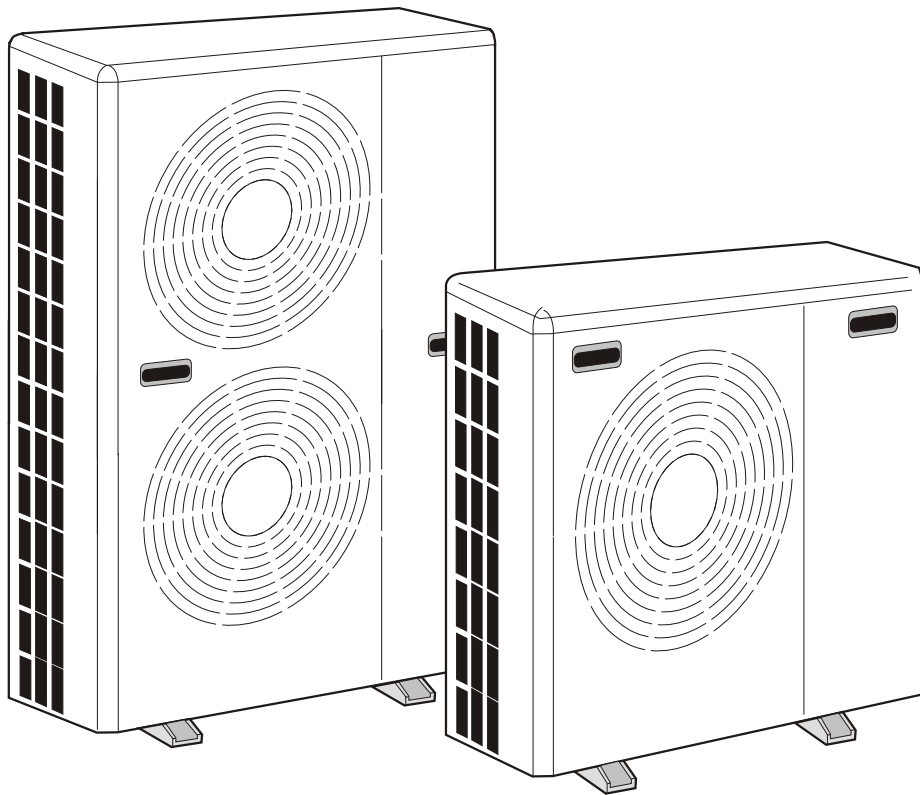

# Content

<b>Safety Precautions</b> .....	2
General .....	2
Transport and storage .....	2
<b>Components</b> .....	3
<b>Wired LCD Controller</b> .....	4
<b>Error Code</b> .....	11
<b>Installation</b> .....	12
<b>Electric connection</b> .....	17
<b>Test run</b> .....	19

# Safety Precautions

## Note!

*It is required to read the Safety precautions in detail before operation. The precautions listed below are all-important for safety, please obey without fail.*

## General

- ❗ Make sure that the fixed ground wire in the building is securely connected to earth.
- ❗ Wiring tasks should be carried out by qualified electricians only, in addition, they should check the safety conditions of power utilization, for example, check if the line capacity is adequate, and check if the power cable is damaged.
- ❗ Users must not install, repair or relocate the unit.  
Improper treatment might lead to the accidents e.g. personal injury caused by fire, electrical shock or unit's falling-off, and water leakage in the machine. Please contact professional repair and service department of local dealer.
- ❗ The unit shall not be installed at a spot with potential hazard of leakage of inflammable gas.  
In case the leaked gas is congregated around the machine, there might be the risk of explosion.
- ❗ Make sure that the foundation of installation is stable.  
If the foundation is unstable, the outdoor unit may drop and cause a casualty accident. so this must be validated carefully.
- ❗ Make sure that the electric leakage protection switch is fixed.  
If no electric leakage protection switch is fitted at the beginning of the electric supply, it maybe cause electric shocks or fires.
- ❗ If any abnormality occurs in the unit (such as burned taste inside the unit), cut off the power supply immediately, and contact professional repair and service department of local dealer.
- ❗ Please observe the follow items when cleaning the unit.  
Before cleaning, shut off the electric supply of the unit firstly to avoid injuries caused by fan in operation.  
Do not rinse the unit by water because the rinsed unit may cause electric shock.
- ❗ Make sure to shut off the electric supply before maintaining the unit.
- ❗ Please do not insert fingers or sticks into air outlet or air inlet.

## Transport and storage

- ❗ The machine must be transported and stored vertically.

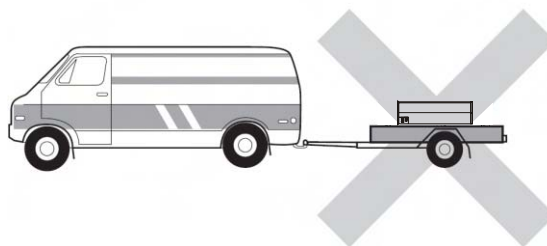

# Components

AH-6,AH-8,AH-11,AH-15DC

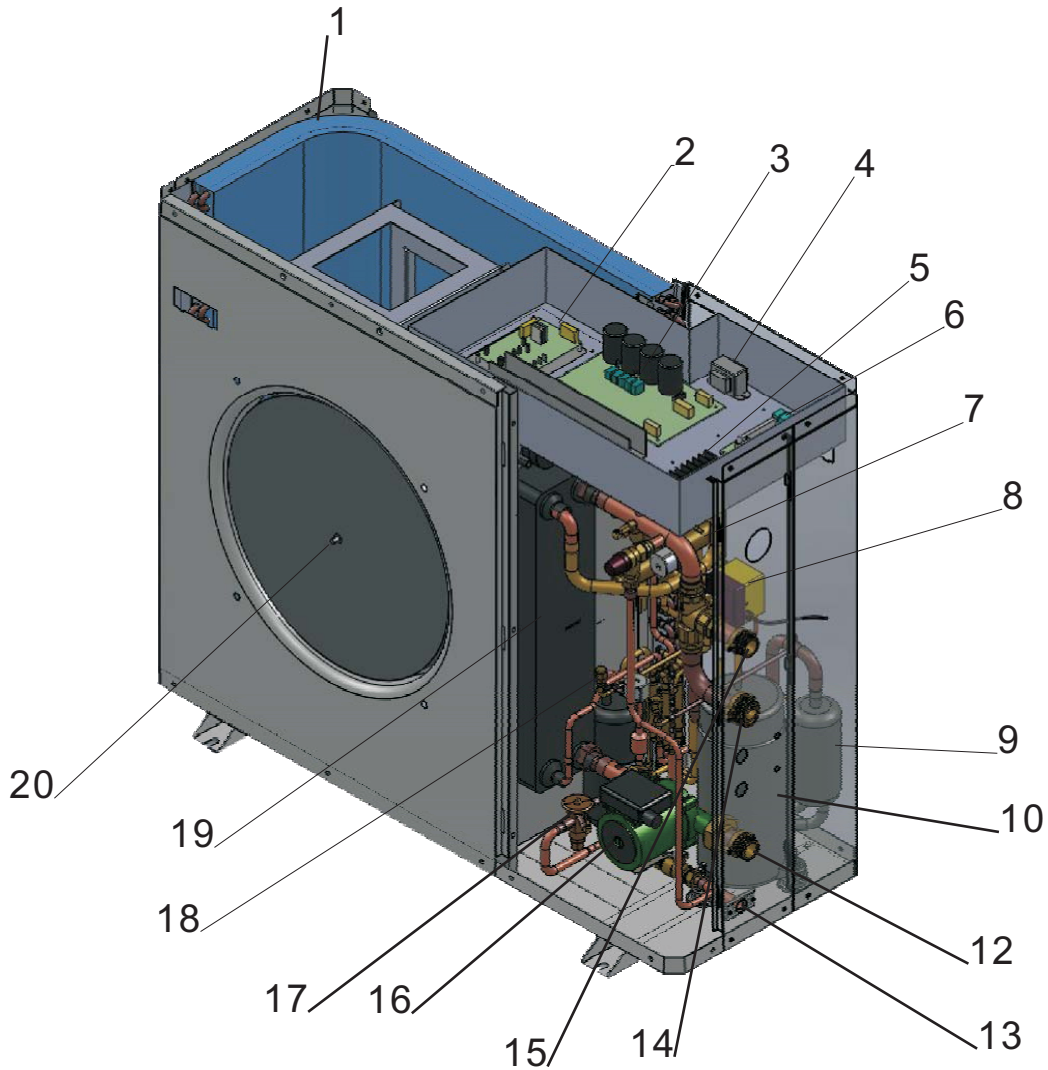

## Position

## Component

1	Evaporator
2	IPM Module
3	Main control board
4	Transformer
5	Terminal blocks
6	Water system control board
7	4 way valve
8	3 way valve
9	Gas liquid isolator
10	Compressor

## Position

## Component

12	Water inlet
13	Drain
14	AC Outlet
15	DHW Outlet
16	Water circulation pump(Optional)
17	Thermal Expansion Valve
18	Needle valve
19	Plate heat exchanger
20	Fan and fan motor

## 1 Wire controller

Wire controller contains a LCD and 6 operational keys (as show below). It can keep memory when power off and be a timer.

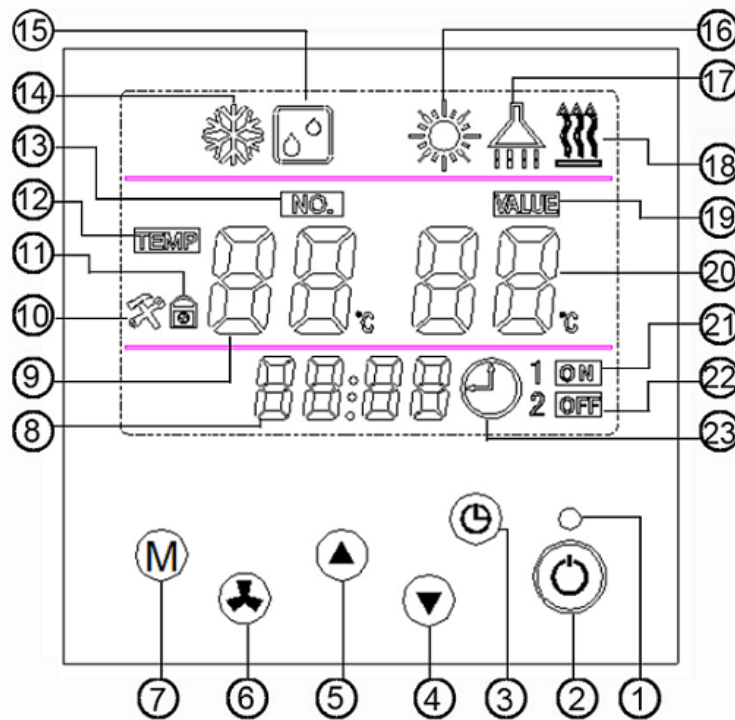

## 2. Key functions

- (1) Double-colored indicator light: when standby, blue light on; when compressor worked, red light on; when breakdown happened, red light on. For more details, please check fault code sheet.
- (2) Key "on/off" : power on /power off.
- (3) Key "time adjusting": adjust clock or set time.
- (4) Key "down": it's a combined key to decrease numerical value, continuous press, then continuous decrease; short press, then decrease by 1.
- (5) Key "up": it's a combined key also, but opposite to down key. Continuous press, then continuous increase; short press, then increase by 1.
- (6) Key "confirm": confirm previous operations
- (7) Key "mode": operational mode's switch. It's a combined key also.

## 3. Icon Meaning

NO.	Icon meaning	NO.	Icon meaning	NO.	Icon meaning
8	Clock display	9	Returned AC Temp.	10	Maintain icon
11	Lock icon	12	Temperature icon (Reserved)	13	Parameter number icon
14	AC Cooling icon	15	Sterilization icon	16	AC heating icon
17	Sanitary hot water icon	18	Water/ground source display	19	Parameter icon
20	Domestic Hot Water temp	21	Timer on icon	22	Timer off icon
20	Sterilization days display	21	Sterilization on display	22	Sterilization off display
23	Clock icon				

## . 1 Switch the unit On and off

To start the unit, press and hold the On/Off key for one second

To stop the unit, press and hold the On/Off key for one second

## . 2 Mode switch ( 5 modes in total )

A. Under mode standby or On, press the M key repeatedly, the following icons will flash by recycling.

**AC cooling -> AC heating -> DHW(Domestic hot water)-> AC cooling + DHW ->AC heating + DHW**

When selected a mode, press  button to confirm, then the icon will be solid, heat pump will perform as selected.

B. When in mode AC cooling +DHW or AC heating & DHW, DHW heating will be the priority.

C. When select DHW mode, only hot water system working, no air conditioner working.





D. When select air conditioner mode, only air conditioner system working, no sanitary hot water system working.

E. Sterilization is independent and auto-operated. You can change parameter according to need.

## .3 Procedures of setting parameter change





















A. When in settled mode, the unit will operate in accordance with the factory default temperature or last modified temperature.

### B. Modification method for settled temperature

In the on / standby mode, press key M and  for 3 seconds, the current operating mode light will flash; by press the M key, you can switch modes in the following order: Cooling / heating / hot water / sterilization; press  to confirm the mode and press key  or  to setting value, then press key  to confirm, then exit and save current changes;















if didn't press key  to confirm, it will exit the parameter modification automatically 15 seconds later. Previous Changes will not be saved.

Detailed settings as follows:





NO.	Meaning	Settled temperature range	Default temperature	operation for modify settled parameters
1	AC cooling returned water temp	10°C ~ 25°C	12°C	M+  → M →  →  or  → 
2	AC Heating returned water temp	10°C ~ 55°C	45°C	M+  → M →  →  or  → 
3	sanitary hot water heating	( AU ) 10°C ~ 60°C	50°C	M+  → M →  →  or  → 
4	Legionella Anti-bacteria	60°C ~ 70°C	65°C	M+  → M →  →  or  → 

C. Time setting procedure for health sterilization

Only in sanitary hot water mode, health sterilization will work. If sanitary hot water mode off, health sterilization will fail to work.

In on or standby mode, first, press key M and  for 3 seconds, second, press key M, 15 icon appears, then press the  or  to set sterilization temperature, press key  to confirm, the number of days will flash and show the original or default value 7 (that means 7 days), press key  or  to increase or decrease the number of days at predetermined intervals, the minimum of 7 days, maximum of no more than 99 days, after that, press key  to confirm. At this time, "ON" character appears, "hour" appears and flashes, show the original setting or the default value (default value 01 means it will start at 1:00 am), followed by press key  or  to modify (0-23), after that, press key  to confirm, then the new time start running. "ON" character disappears, "OFF" character appears, "minute" value flashes and shows the original or default value (default value is 10), followed by press key  or  to change (minimum is 10, maximum no more than 99), after that press key  to confirm and exit change mode. If didn't press key  to confirm, machine will exit change mode automatically after 15 seconds. But settings did right now will become invalid.

**4 Time adjustment**

Press key , time "hour" value will flash, then press key  or , the value will increase or decrease. Press key and keep, the value will increase or decrease constantly as you want. After Settle down, please press key  to confirm, then exit from time adjusting mode.





**5 Time setting**

You can set one time to start and one time to off. And select one time working or cyclic working.

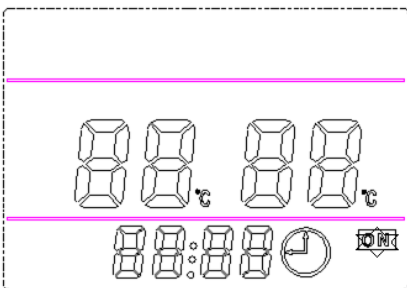
A. settled time on method:

(1) Press  for 3 seconds and come to time setting,  will flash as show below.



(2) Press key  or  to modify time value, and press  to confirm. This setting only valid for one time. If you want time setting to work cyclic, please press key  after time setting, then press key  to confirm.

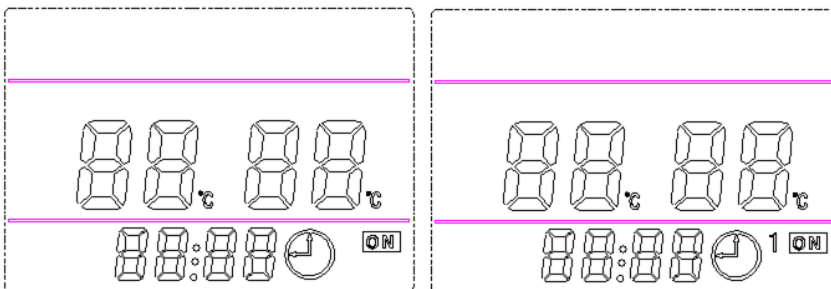

B. Timing off method are the same as timing on method.

C. Please press key  for 3 seconds and come to timing mode, press  to cancel time setting.

## 6 Parameter Checking and setting

Please press key M+▲ for 3 seconds and enter to parameter setting mode as show below.

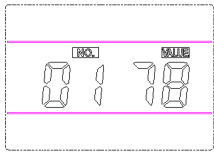

“01”is parameter code,“78”is parameter values.

Other items' parameters meaning are the same with above picture showed.

Parameter list as below:

NO.	Name	range/meaning	default	status
00	power down auto restart	0: not recovery; 1: restart	1	check/set
01	DHW water temp. return differential	2~15℃, minus differential	2℃	check/set
02	air conditioning return differential	2~15℃, minus differential	2℃	check/set
03	Copper pipe temp to start defrost	-20~5℃	0℃	check/set
06	defrost stop temp.	10~35℃	30℃	check/set
07	Max defrost duration time	15~99 mins	15	check/set
08	defrost interval time between 2 defrosts	15~99 mins	35	check/set
09	air temp to start DHW electrical heater	-20~20℃	0℃	check/set
10	air temp. to start AC electrical heater	-20~20℃	0℃	check/set
11	DHW working frequency limit.	2~10, (refer to DHW frequency 20hz~100hz)	10	check/set
12	Compressor discharge air protection temp	A0~C7 = (100~127℃)	B0	check/set
13	Defrost interval time multiply rate	0: No defrost 1~4: Parameter08*1~4	1	check/set
14	function parameter	0: G3 is seasonal switch valve; 1: G3 is solar pre-heat valve;	0	check/set
26	AC water pump running mode	0, 1, 2 (0:not stop, 1:stop when reach target temp, 2: run 1 minute every 15 minutes stopping)	0	check/set
27	2 <sup>nd</sup> heat source control validation	0, 1 (0: 2 <sup>nd</sup> heat source control disable; 1: control enable)	0	check/set
28	Air temp to start 2 <sup>nd</sup> heat source control	-15~10℃	-15℃	check/set

Note:

1.Press Ⓜ key for 5 seconds, after heard 1 beep, The Factory default parameter will be reset.

### 2. Usage of Parameter 14: G3 function parameter (ref to Solar Application 1)

when this parameter is 1, when air conditioning heating run, it will compare solar water tank temp with air conditioning returned water temp, when solar water tank temp is 5 or more degree higher than air conditioning returned temp, the 3-way valve G3 electricity supply will be on; when solar water tank temp - air conditioning returned temp is less than 2 centigrade, G3 electricity supply will be off. This function is to use solar to preheat for room heating and DHW tank water.

When this parameter is 0, G3 is seasonal switch valve, when the heat pump is working for heating, G3 is on, when heat pump is working for cooling, G3 is off.

Normally use one 3-way valve with 3 wires. 2 wires are always connected with electricity supply and 1 signal wire is connected with heat pump G3 terminal port to enable function.

### 3.Usage of Parameter 26: AC water pump working mode (ref to Page 16)

If no AC buffer tank, The Parameter 26 better to be set to 0, then AC water pump will work continuously to keep the AC loop water temp always the same.

If with AC buffer tank, the parameter 26 can be set to 1, but the AC inlet water temp must be changed to insert to AC buffer tank as reference to page 16.



## .7 Machine operational status Checking

Press both key M and ▼ for 3 seconds, then entered machine status form. Show as below.

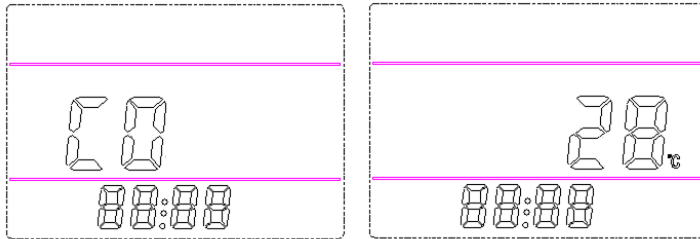

“C0” is part or parameter NO. , “28” stands for parameter. Parameter 0 means system on, 1 means system off. For more detail, please check form below.

Press M+ ▼ for 3 seconds to search and check parameters .

NO.	Name	range/meaning	status
00	Outdoor pipe temp.	-30~97℃	check
01	Compressor Exhaust gas temp.	inverter: -30~97℃ (0: disconnected; 1: connected)	check
02	Ambient temp.	-30~97℃	check
03	AC outlet water temp.	-30~97℃	check
04	DHW pipe temp.	-30~97℃	check
05	Solar pipe water temp.	-30~97℃	check
06	Switch input status	0 (heating&cooling) 1 (heating only)	check
07	Switch input status	0 (air source); 1 (water source)	check
08	Switch input status	0 (DHW invalid); 1 (DHW valid)	check
09	Switch input status	0 (G1 valid); 1 (G1 invalid)	check
10	high pressure switch status	0 (off); 1 (on)	check
11	overcurrent protect switch status	0 (off); 1 (on)	check
12	low pressure switch status	0 (off); 1 (on)	check
13	inside water flow switch	0 (off); 1 (on)	check
14	outside water flow switch	0 (off); 1 (on)	check
15	The 2nd high pressure switch sta	0 (off); 1 (on)	check
16	Defrost temp		check
17	air conditioning antifreeze temp		check
18	System antifreeze temp		check
19	Compress	Inverter: actual running rate	check
20	Outdoor fan motor	1: run; 0: stop	check
21	crankcase heater	1: run; 0: stop	check
22	4-way valve	1: run; 0: stop	check
23	Bypass valve	1: run; 0: stop	check
24	solenoid valve 1	1: run; 0: stop	check
25	solenoid valve 2	1: run; 0: stop	check
26	solenoid valve 3	1: run; 0: stop	check
27	Electrical heater 1	1: run; 0: stop	check
28	Electrical heater 2	1: run; 0: stop	check
29	C4 water pump	1: run; 0: stop	check

29	C4 water pump	1: run; 0: stop	check
30	C5 water pump	1: run; 0: stop	check
31	C6 water pump	1: run; 0: stop	check
32	functional parameter	0-99 (accumulated days from last sterilization till now)	check
33	cooling target temp		check
34	heating target temp		check
35	DHW target temp		check
36	Sterilization temp.		check
37	outdoor unit module temp.	-30~97℃	check
38	Outdoor unit returned gas temp.	-30~97℃	check
39	Internal pipe temp.	-30~97℃	check

**8 Displays for different kinds of modes**

( 1 ) tritherma water/ground source heat pumps icons      ( 2 ) air source heat pumps icons:

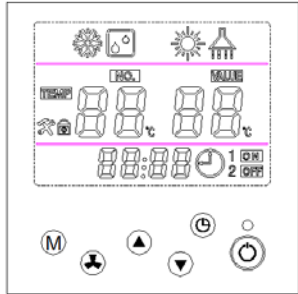
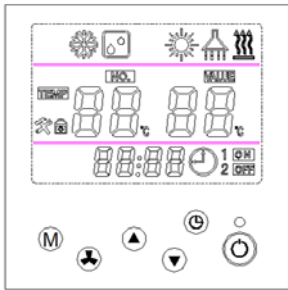

( 3 ) powered off display

(water source heat pump has water source icon. If it has timer on/off setting, there is timer icon to indicate. )

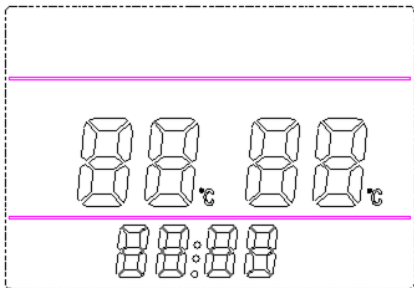

( 4 ) AC cooling display

( 5 ) heating display

(water source heat pump has water source icon. If it has timer on/off setting, there is timer icon to indicate. )

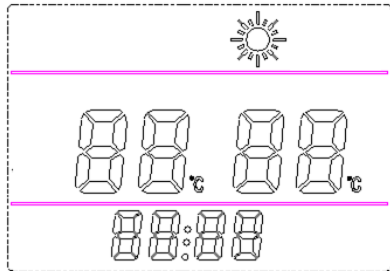
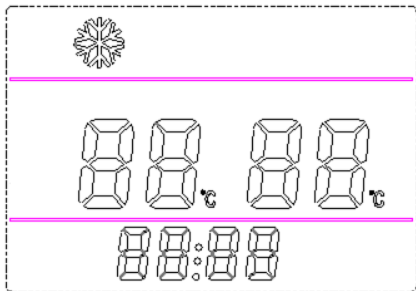

( 6 ) sanitary hot water display

(water source heat pump has water source Icon. If it has timer on/off setting, there is timer icon to indicate. )

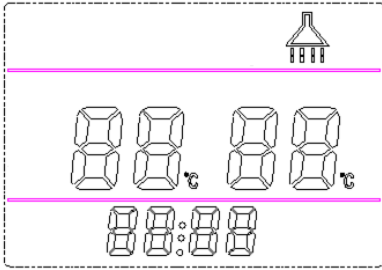

( 7 ) AC cooling and sanitary hot water display

( 8 ) AC heating and sanitary hot water display

(water source heat pump has water source Icon. If it has timer on/off setting, there is timer icon to indicate. )

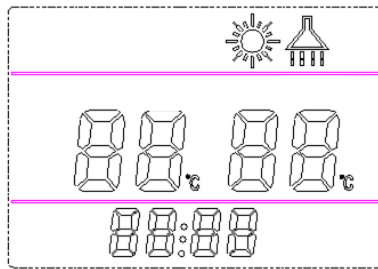
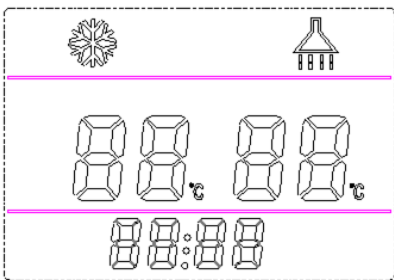

**9 way of communication**

Non-polarity double wire, maximum running length is 100 meters and point to point connected. Back view of wired controller showed below.

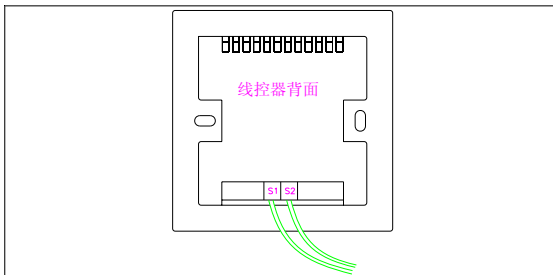

**10 Function Selection Switch: SW1**

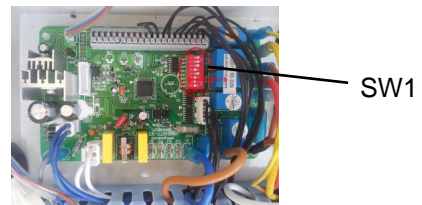

(after change, need be repowered to enable the change)

SW1-8	OFF: cooling valid; ON: cooling invalid
SW1-7	OFF: heating valid; ON: heating invalid
SW1-6	OFF: DHW valid; ON: DHW invalid
SW1-5	reserved
SW1-4	OFF: inverter outdoor model; ON: on/off outdoor model
SW1-3	reserved
SW1-2	reserved
SW1-1	OFF: geothermal; ON: air source

## ERROR CODE

When machine has error, the control will show “P” or “E” at AC temp location and show error code at DHW temp location, press key ▼ to search more error codes happened at the same time. Please see table below for error code meaning.

Code display like EX or Px, eg: E2、P5

code	Breakdown meaning	Outdoor Led2	Remark
E1	compressor discharge gas high temp. protect	Flash 10 times	1.Refrigerant low 2. throttling device problem
E2	Outdoor air temp sensor fault	Flash 3 times	Sensor open circuit or short circuit
E3	Pipe temp or returned air temp sensor fault	Flash 6 times	Sensor open circuit or short circuit
E4	AC returned water temp. sensor fault	No flash	stop compressor in AC
E5	AC output water temp. sensor fault	No flash	stop compressor in AC
E6	Hot water temp. sensor fault	No flash	Hot water, stop compressor
E7	Solar water temp. sensor fault	No flash	Compressor run
E8	coil hot water protect	Flash 15 times	Decided by Outdoor unit
E9	system antifreeze twice	No flash	Stop compressor
EA	DHW antifreeze twice	No flash	Stop compressor
Eb	Indoor refrigerant pipe temp sensor error	No flash	
EC	Water source inlet water temp sensor error	Flash 16 times	
Ed	Water source outlet water temp sensor error	Flash 16 times	
EE	Water source antifreeze protection	Flash 15 times	1.Water source heat exchange not sufficient or water source water temp too low. 2.water source water flow not enough
EF	Water source water flow volume not enough	Flash 17 times	Stop compressor
F1	Voltage protect	Flash 1 times	Voltage too high or too low (after voltage become normal 165~265VAC, unit auto recover)
F2	Rating module PFC error	Flash	
F3	Compressor stopped abnormally	Flash	
F4	outdoor module radiator sensor fault	Flash 5 times	IPM module temp sensor error
F5	Outdoor unit current sensor fault	Flash 8 times	Current sensor fault or not cross the test wire
F6	IPM or module control board fault	Flash 14 times	Communication not good or IPM broken
F7	Compressor fail to start	Flash	Decided by Outdoor unit
F8	Outdoor unit overcurrent	Flash 11 times	Compressor current too high
F9	Exhausted gas temp. sensor fault	Flash 7 times	
FA	Outdoor module overheat,over-current	Flash 5 times	IPM temp too high, compressor current too high
FB/E8	Outdoor coil overheat	Flash 15 times	Outdoor heat exchange not sufficient
P1	high pressure protect	Flash 2 times	1.Refrigerant high 2. throttling device problem 3. High pressure switch fault
P2	Low pressure protect	Flash 9 times	1.Refrigerant low 2. throttling device problem 3. Low pressure switch fault
P5	indoor unit water flow fault	Not flash	1. water flow too small. 2.Water flow switchfault
P6	outdoor unit(water source side) water flow fault	Flash 17 times	1.water source side water flow too small. 2.Water flow switch fault
P7	phase loss	Flash	Power connection fault
P8	Wrong phase	Flash	Power connection fault
P9	Communicate fault	Flash	Power connection fault or communication fault

# Installation

## 1. Installationmethod

### Method 1

#### Only DHW

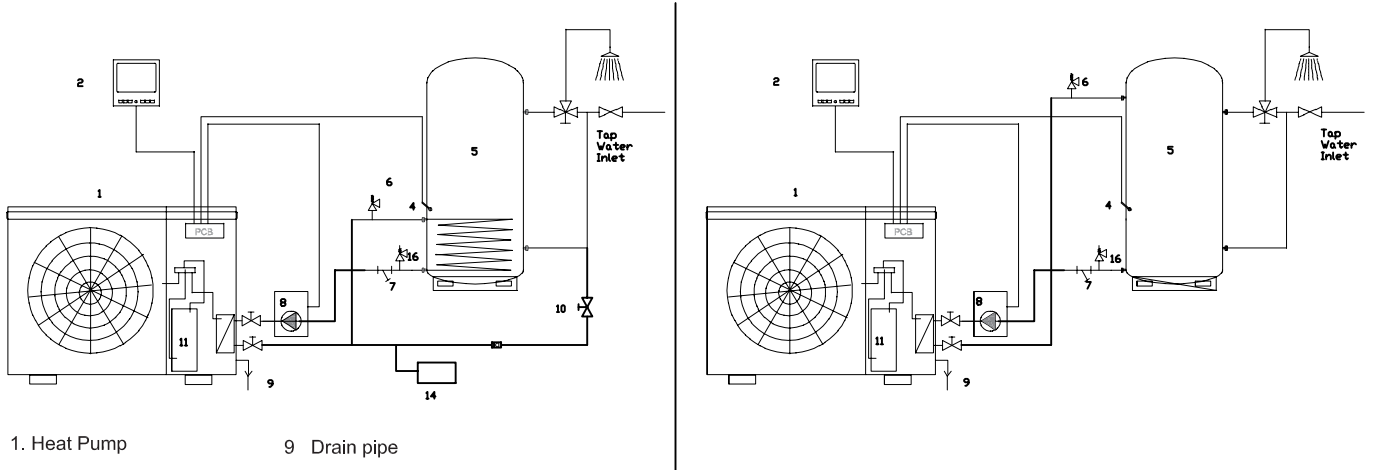

- |                     |   |
|---------------------|---|
| 1. Heat Pump        | 9 Drain pipe                              |
| 2. Wired Controller | 10 Ball valve                             |
| 3. DHW water pump   | 11. Compressor                            |
| 4. DHW temp sensor  | 12. Air Conditioning plate heat exchanger |
| 5. DHW water tank   | 13. Hot Water Plate heat exchanger        |
| 6. Safety valve     | 14 Expansion Tank                         |
| 7. Filter           | 15 Ball valve                             |
| 8. Water pump       | 16/17 Air discharge valve                 |

### Method 2

#### DHW with Room Heating

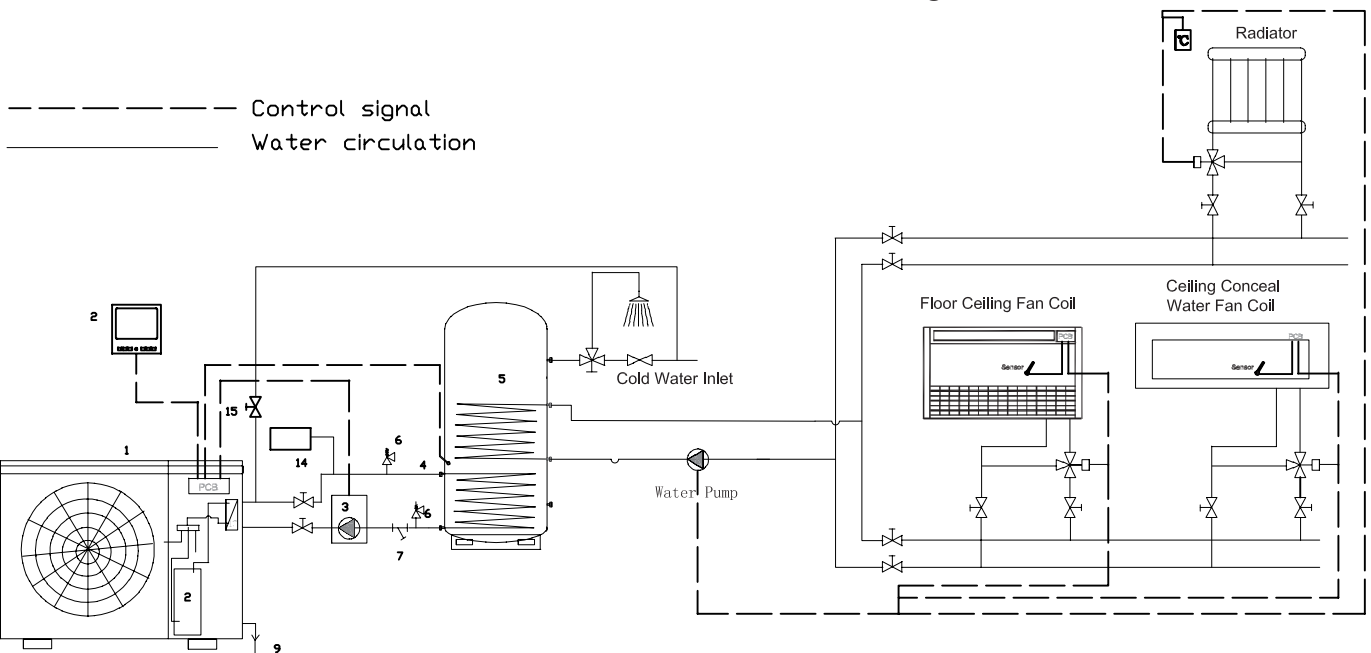

## Method 3

## Air Conditioning Heating and Cooling

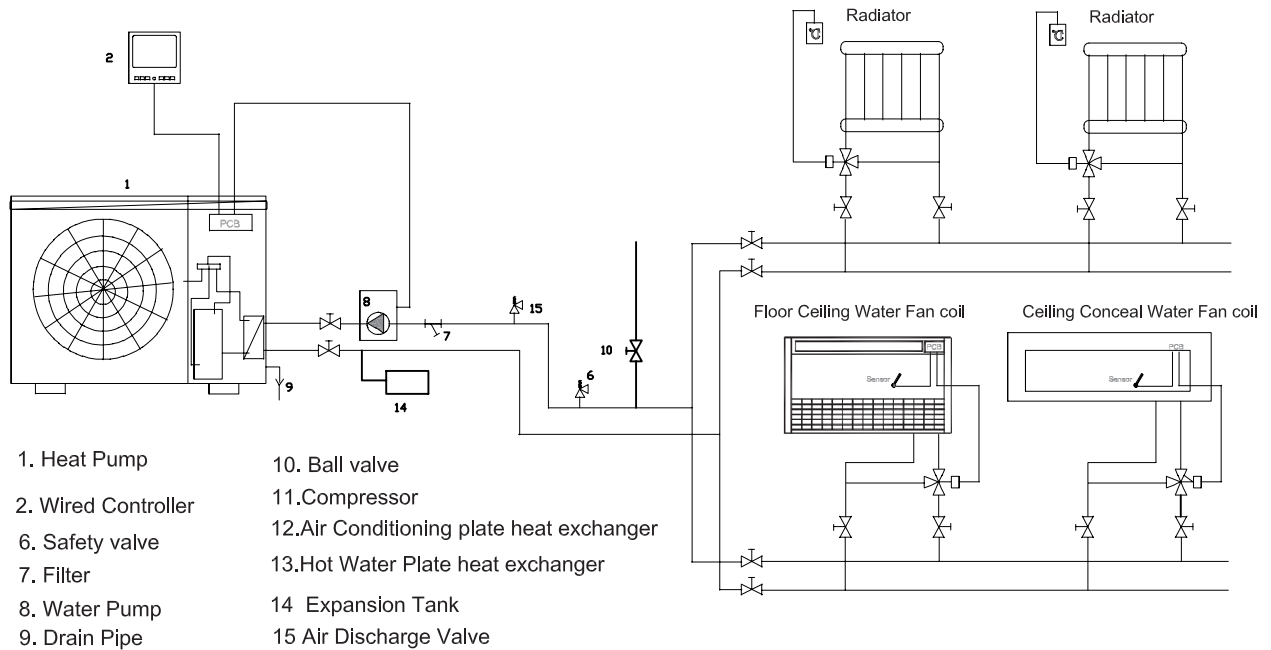

## Method 4

## Heating & Cooling & DHW

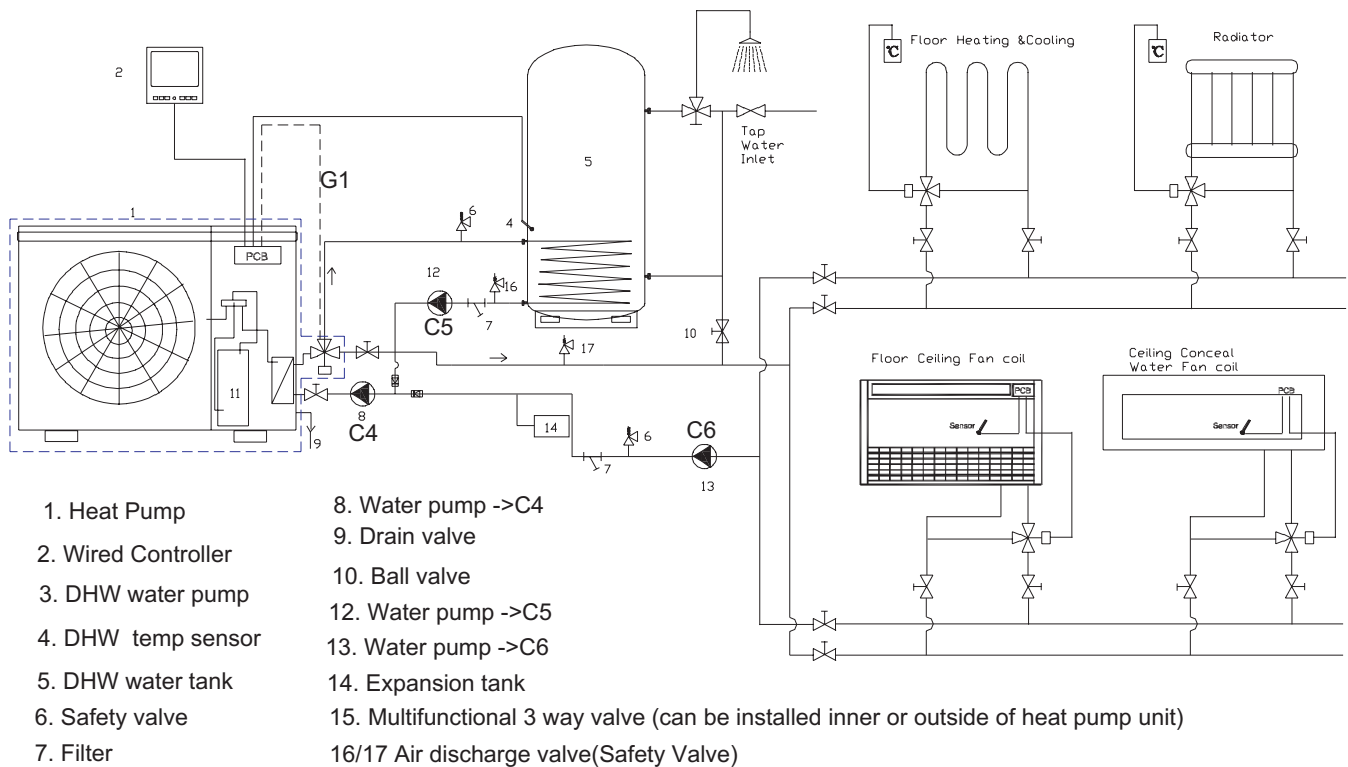

### Note:

1. C4 water pump and multifunctional box can be built inside of heat pump according to order requirement.
2. C4 water pump can be used for both DHW and air conditioning water circulation.
3. installer should check the actual water resistance and make sure to keep enough minimum water flow volume, if necessary, more water pumps should be added for DHW (C5 water pump) and air conditioning(C6 water pump) water circulation. The water pump connection can be found in wiring diagram.
4. Safety valve(air discharge valve) should be installed at the top of the circulation system for easy air discharge. Air conditioning circulation can utilize the fan coil or radiator air discharge valve.

# Installation

## 2. Installation with solar assistant

### Application 1 Only DHW with Solar

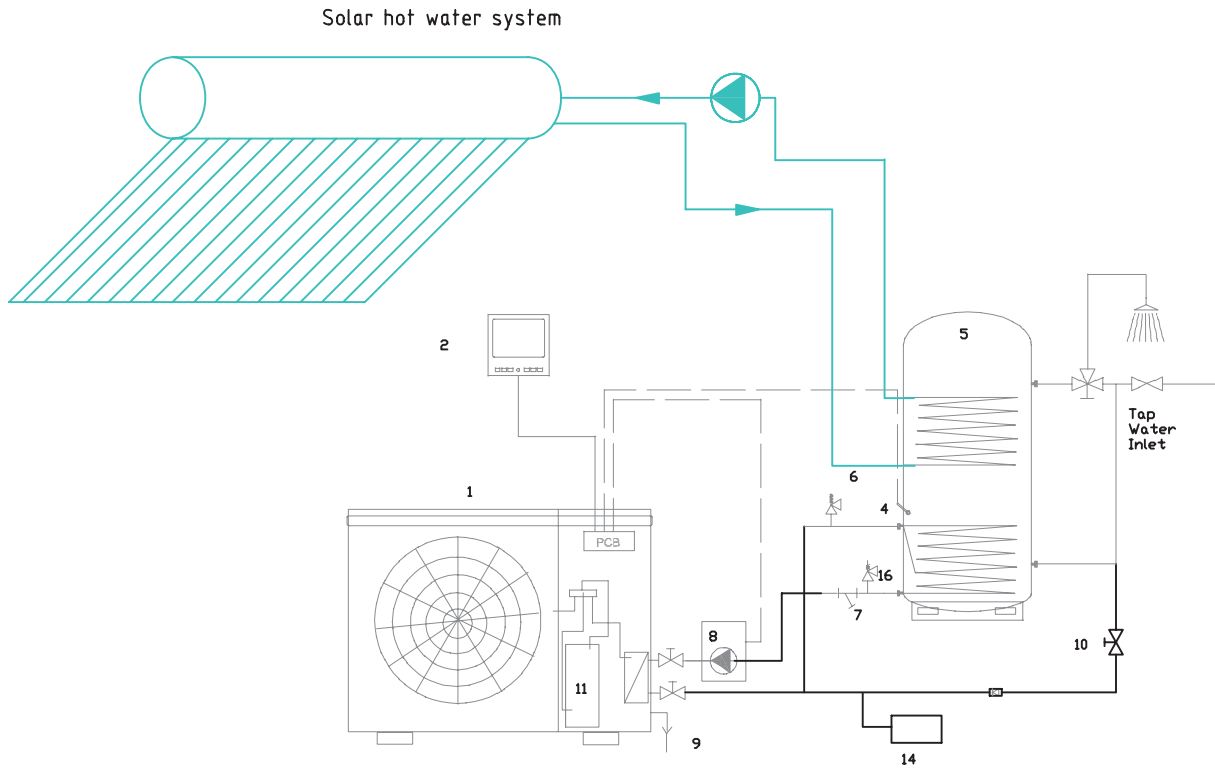

### Application 2 Multifunctional heat pump with solar assistant DHW

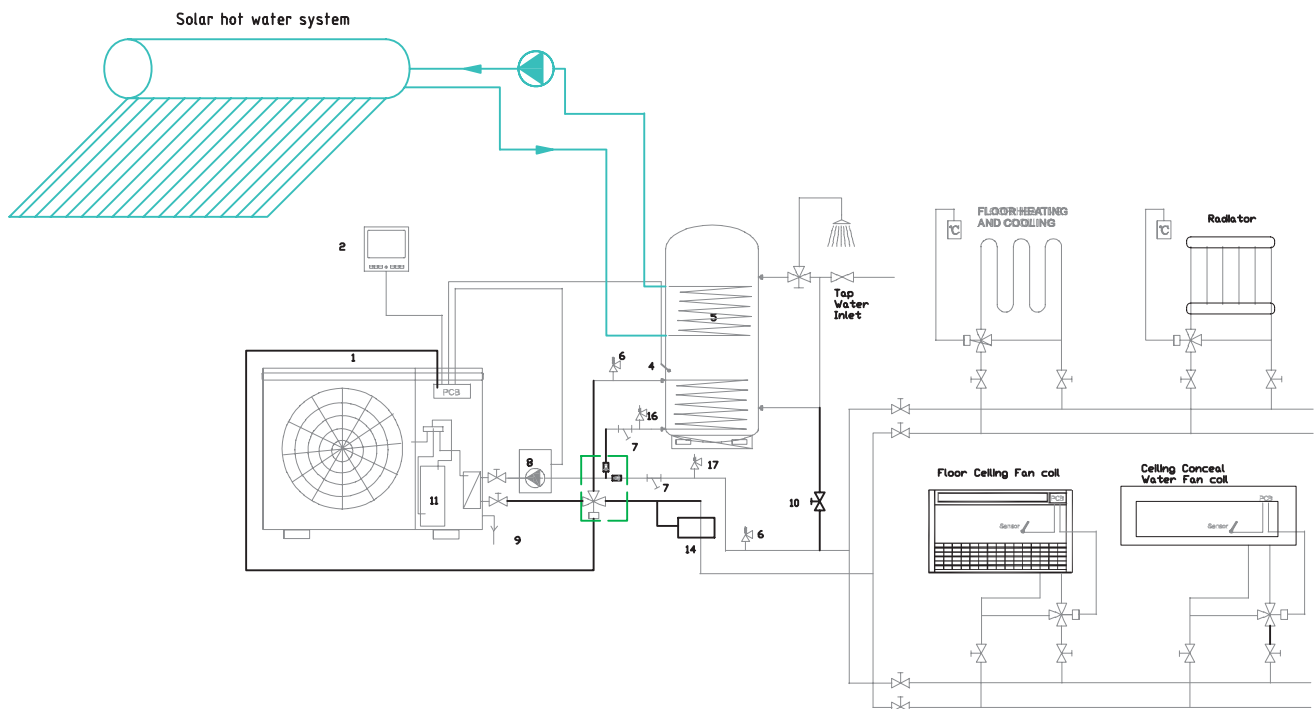

# Installation

## Application 3 The most energy saving application

### Multifunctional heat pump application for solar assist for room heating and DHW

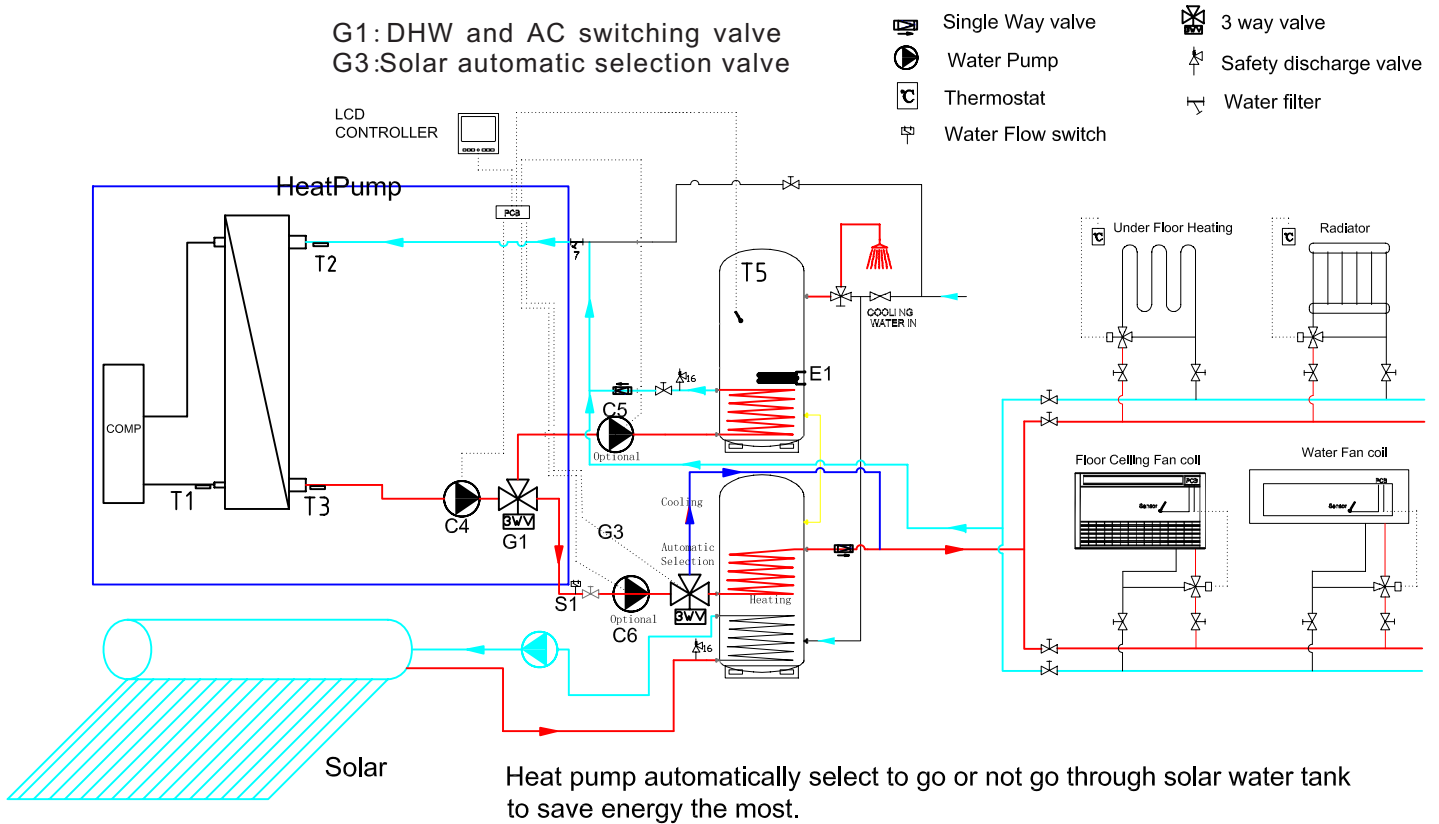

### Application with AC water pump stop when reach target temp

1. Set parameter 26 to 1. Must change the AC inlet water temp sensor(6)IN2 into buffer tank.(ref to wiring diagram).
2. Must add AC buffer tank and 2 water pumps at both side of the buffer tank. The room side water pump is controlled by room thermostat. Heat pump side water pump is controlled by heat pump C4 or C6.
3. Must use brine not pure water at both side of the buffer tank.

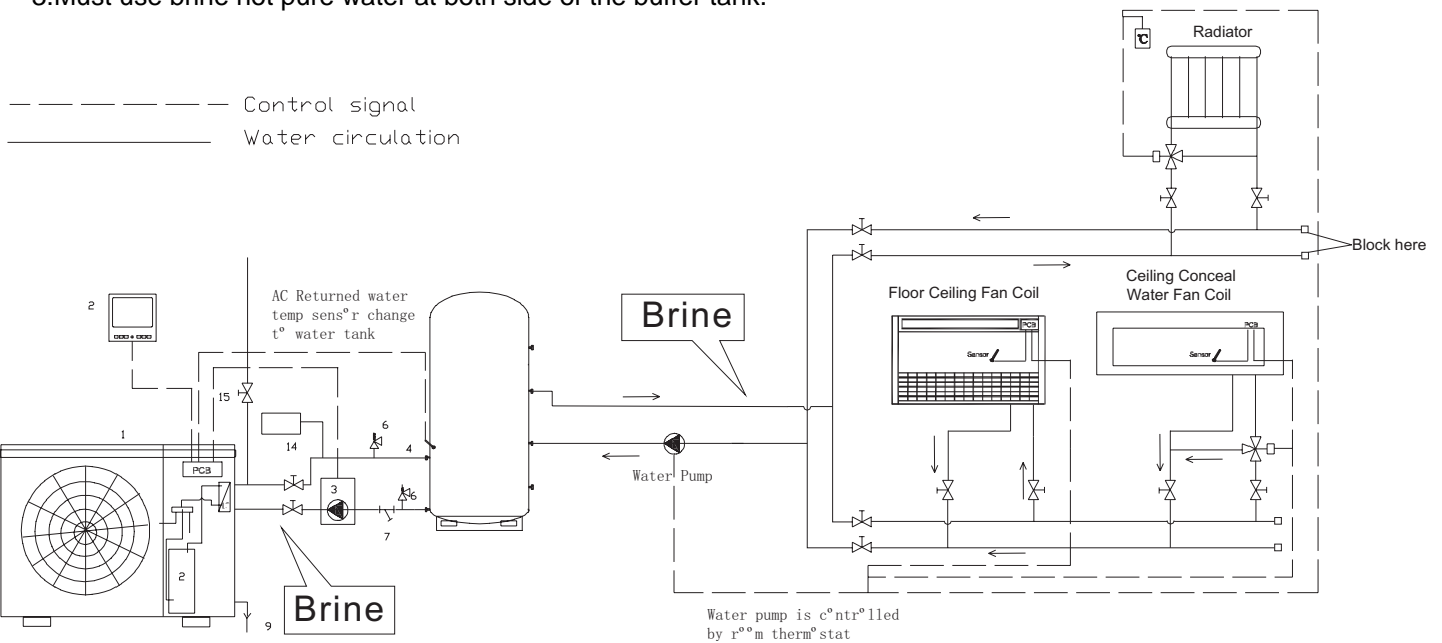



## 5. Installation

### Installation position

**Note!**

**Installation must be carried out by professional personnel.**

- 1 If the unit is to be installed on the floor, its undercarriage should be heightened, to avoid ingress of accumulated water in rainy season. In snowy areas, it is important to prevent accumulated snow from blocking up the air-out. The recommended height is 20cm to 30cm.
- 2 Drain ditch or other facilities should be arranged under the outdoor unit, to avoid the environment influence because of water discharge.
- 3 To install the unit at balcony or top of building, the installation site must meet the allowable bearing capacity of building structure, without affecting the structural safety.
- 4 Ensure the unit is well ventilated, direction of air exhaust is kept away from windows of neighboring buildings, and the exhaust air cannot flow back. moreover, adequate service clearance should be kept around the unit.
- 5 The unit should not be installed at places accompanied with oil, inflammable gases, corrosive components e.g. sulfur compound, or high-frequency equipment.
- 6 The unit must be installed upon reliable machine base or framework. Weight capacity of framework should be 3 times of the body weight, and safeguard measures should be taken to avoid malfunction of fastenings.
- 7 The unit should not be installed at sites with typhoon/ earthquake hazards. Midair installation should be avoided as much as possible, for machine falling may result in severe accident.

### Installation in exceptional circumstances(unit:mm)

#### No obstacle in front of the unit

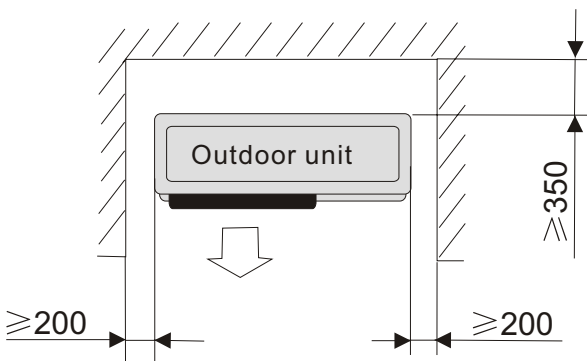

#### Obstacle above the unit

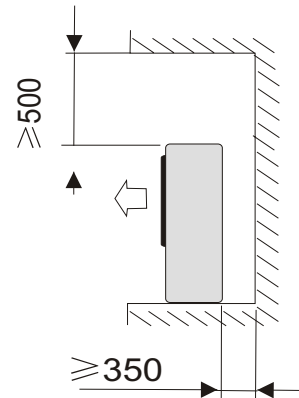

#### Obstacle in front of the unit

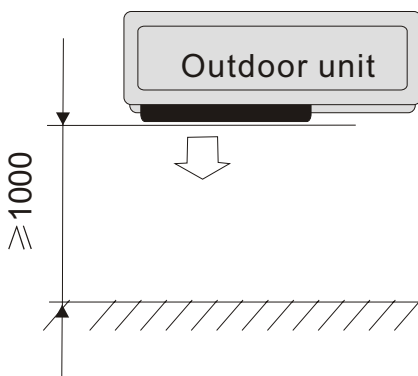

#### Several units in a row

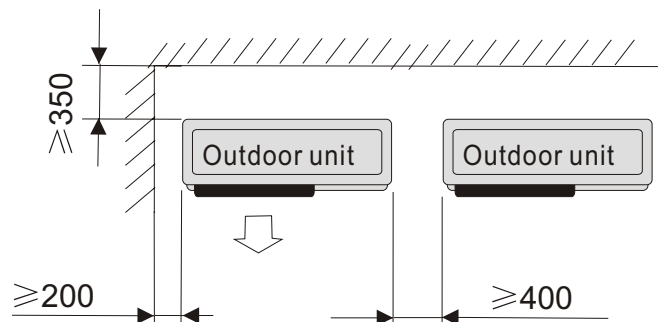

# Electric connection

## General

### Note!

**Electrical installation and service must be carried out under the supervision of a qualified electrician. Electrical installation and wiring must be carried out in accordance with the stipulations in force.**

The heat pump must not be connected without the permission of the electricity supplier and must be connected under the supervision of a qualified electrician.

Wires, spare parts and materials etc. must satisfy the relevant standards issued by the host country or region.

The heat pump does not include an isolator switch on the incoming electrical supply. The power supply cable must be connected to a circuit-breaker with at least a 3 mm breaking gap. Incoming supply must comply with the technical requirements, with ground wire, via a distribution board with fuses.

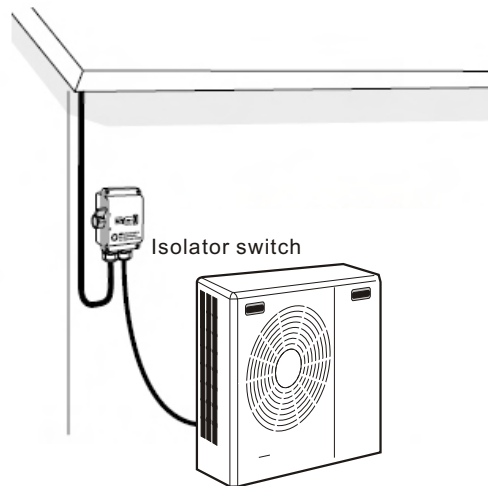

If an insulation test is to be carried out in the building, please make sure to disconnect the heat pump.

To avoid the possibility of false action caused by electromagnetic coupling, the communication wire must be STP(Shielded Twisted Pair). The size of communication wire should not less than 0.5mm<sup>2</sup>.

## Unit Dimension(mm)

AH-6,AH-8,AH-11,AH-15

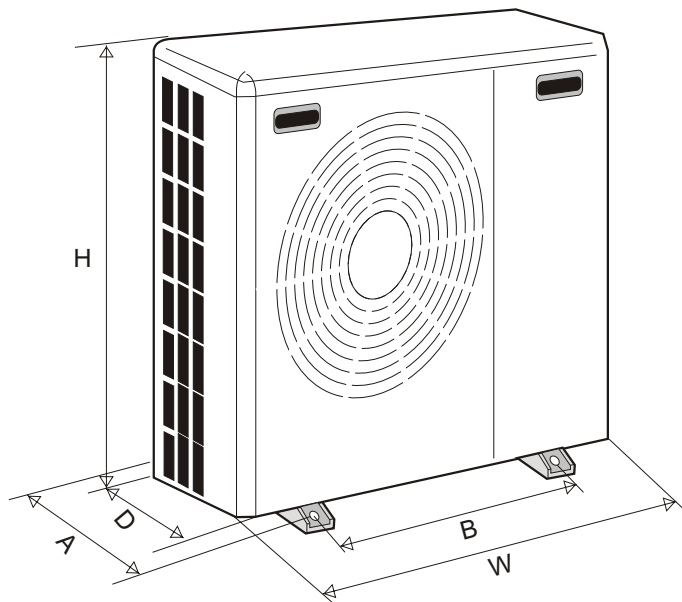

Model	AH-6,AH-8	AH-11	AH-15
W	1091	1091	1091
D	400	400	400
H	780	880	980
A	412	412	412
B	810	810	810

# Electric connection

## Wiring Diagram (AHP-HC type, with built-inside water circulation pump)

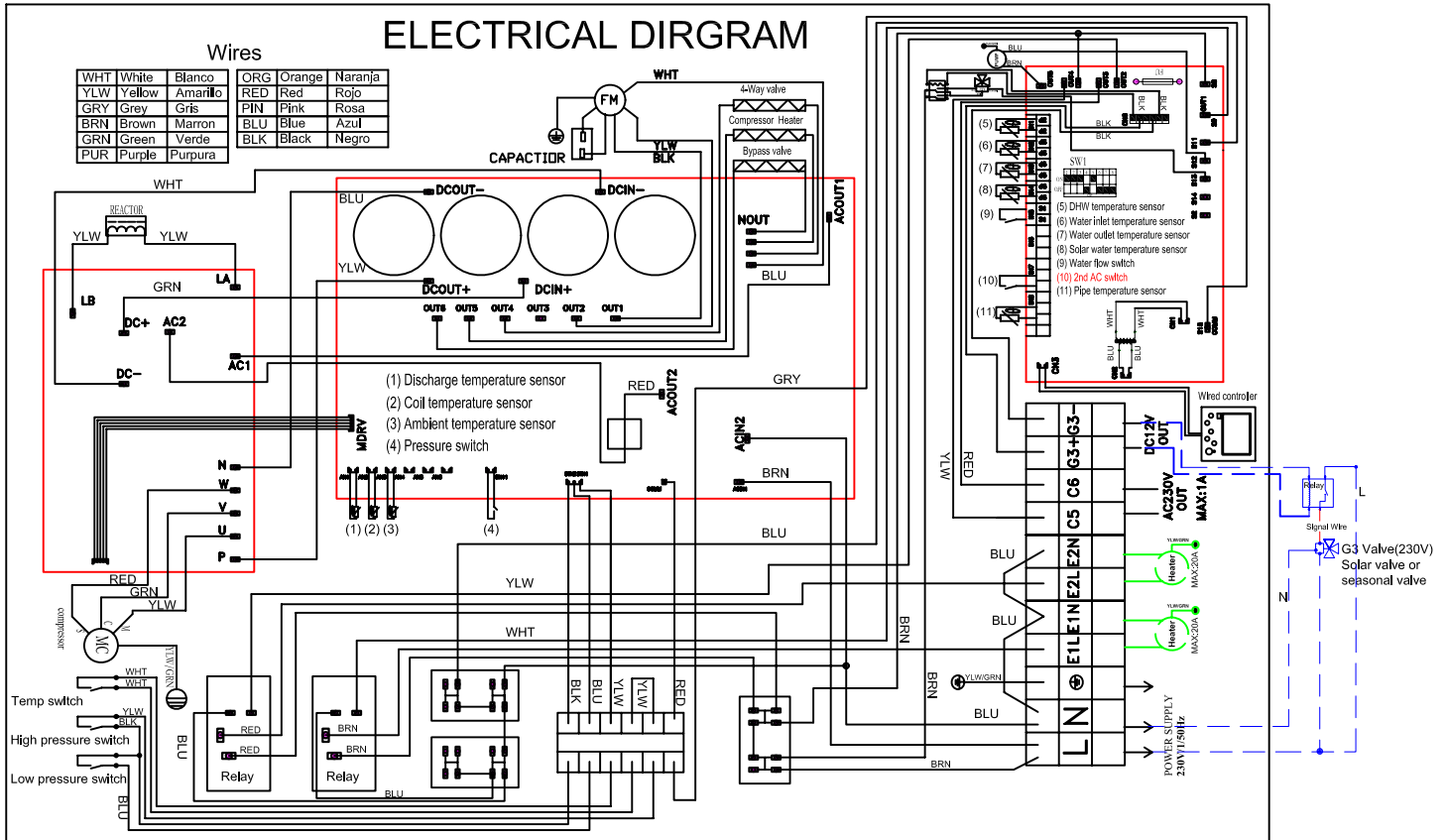

### 2nd AC Switch Function(2nd On/Off Switch)

The 2nd switch function enable our heat pump to be controlled by any additional user's thermostat or remote switches for convenient control.

Function: When 2nd switch is off, the heat pump AC mode will run on standby mode no matter the AC water temp reach target or not. When 2nd switch is on, the heat pump will run according to set temp.

**A. Connected to manual switch**

**B. Connected to any user's thermostat**

**C. Connected to both manual switch together with any user's thermostat**

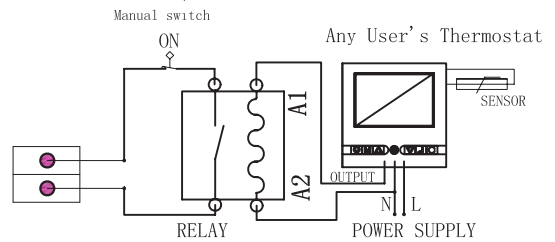
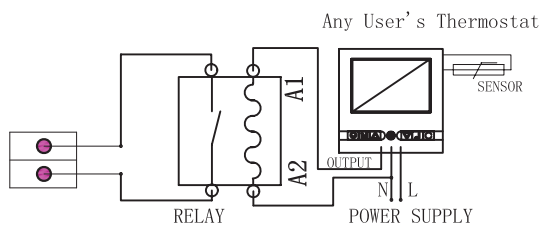
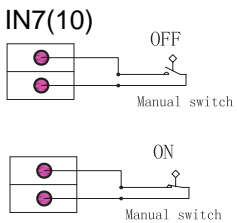

## Test run

### Preparation

After finish the installation tasks, please check the items:

- 1 Check the dip switch setting and short wiring
- 2 Power cable

Check if the power cable is connected correctly, and check if the screws have been screwed down.  
*Please use specified cables.*

- 3 Communication wire

Check if the communication wire is connected correctly.  
*Please adopt specified communication wire.*

- 4 Water circuit

Check if the water pipes are correctly connected, and the pipe dimensions are correct.

Heatproof measures must be taken for water outlet pipes and water inlet.

Check if all the shut off valve and manual valve is opened, check if all the joint is fastened.

### Water or Brine Filling

1 with water pipe connected to the unit's water system, and open all the air exhaust valves in water system and fill water into the system. Keep the air exhaust valve open until there is continuous water coming out of the air exhaust valve. Then close the air exhaust valve.

2. Discharge the air for both domestic hot water system and air conditioning water system, including all usage terminals such as domestic hot water tank, fan coils, radiators and etc. To make sure all system are full of water and there is no air inside the water system.

#### **Note!**

**To avoid the heat pump to be frozen, if the air temp is possible to be under zero degree in winter, you need to use brine(glycol) to replace pure water in case of electricity cut off accident during winter**

### Running

Turn on the heat pump

select heating, domestic hot water mode, check whether the unit is running properly or not, the compressor will be started in 3~5 minute after powered on.

#### **MOST IMPORTANT !**

1. Always keep electricity connection with heat pump to enable the antifreeze function.
2. Select a big enough water pump for the air conditioning water circuit.
3. Make sure it is not in cooling mode during first operation or test running until you make sure the air conditioning circulation pump is working properly and water is recycling smoothly.